

SAFETY INFORMATION

Please read and understand this entire manual before attempting to assemble, install or operate the product.

WARNING

- RISK OF ELECTRIC SHOCK - Before beginning installation, turn off electricity at the circuit breaker box or the main fuse box.
- RISK OF FIRE - Use bulbs specified by the markings and/or labels on the fixture.

CAUTION

- For your safety, read instructions completely before beginning installation.
- If in doubt about electrical installation, consult a licensed electrician.
- Turn off electricity to fixture before replacing the bulb(s).

TOOLS REQUIRED

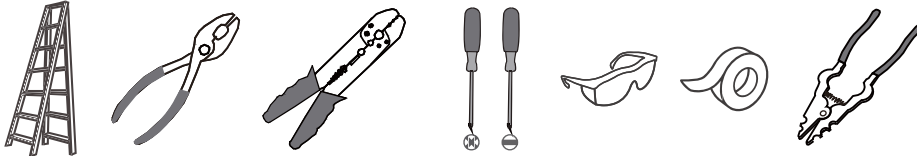

CARE AND MAINTENANCE

- Wipe clean using soft, dry cloth or static duster. Always avoid using harsh chemicals and abrasives to clean fixture as they may damage the finish.

If you need further assistance call Quoizel Customer Care at 1-800-645-3184 (9:00am - 5:00pm EST), or visit us on-line at www.quoizel.com.

PACKAGE CONTENTS



A Fixture Loop
x 1

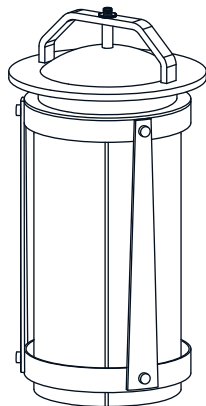

B Fixture Body
with Shade
x 1



C Socket Collar
(Pre-assembled on
Fixture Body)
x 1

MOUNTING HARDWARE

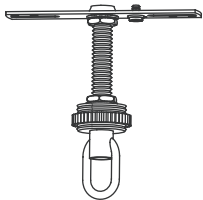

AA Crossbar Assembly
x 1

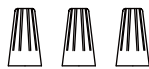

BB Wire Connector
x 3



CC Outlet Box Screw
x 2

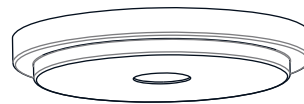

DD Ceiling Canopy
x 1



EE Quick Link
x 2



FF Fixture Chain
x 1

INSTALLATION

1 Remove Packing Material and Glass Shade from Fixture Body

Packing Material

Glass Shade

2 Install Fixture Loop

3 Install Crossbar Assembly

Outlet Box

Canopy Lock Ring

4 Install Fixture Chain

OPTIONAL: Adjust Chain as desired, using pliers and soft cloth (neither included).

Suggested chain length for Ceiling height:
 8 feet ceiling: use 9 links of chain and 2 quick links
 9 feet ceiling: use 19 links of chain and 2 quick links
 10 feet ceiling: use 29 links of chain and 2 quick links.

* Ceiling Canopy shape is varies depends on item purchased.

Ceiling Canopy

Canopy Lock Ring

5 Pull Supply Wires

Pull the supply wires with ground wire through the chain alternate links.

6 Wiring

White wire from supply

Ribbed side of wire from fixture identified with the label "N"

Black (or red) wire from supply

Smooth side of wire from fixture identified with the label "L"

Ground wire from supply

Green ground wire

Ground wire from fixture identified with the label "G"

7 Install Ceiling Canopy

* Ceiling Canopy shape is varies depends on item purchased.

8 Install Shade and Bulb

Install the correct bulb referring to fixture markings and/or labels for maximum wattage.

Recommended Bulb Type (not included):

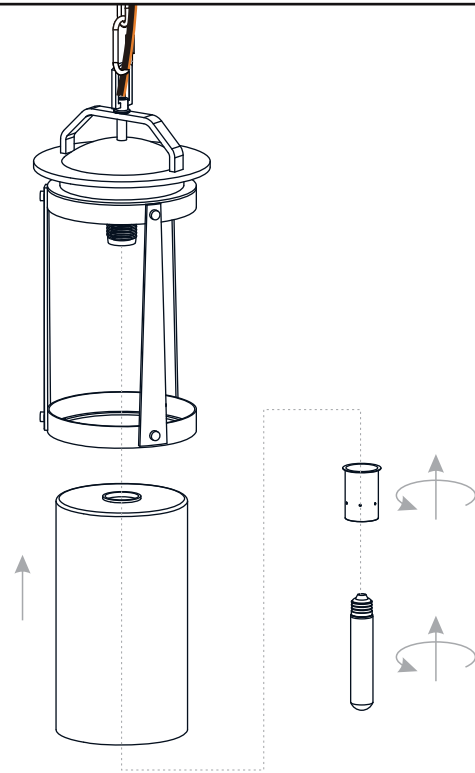
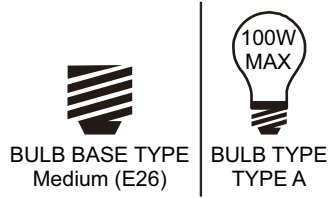

Your installation is now complete! Restore electricity and save this sheet for future reference.