

SAFETY INFORMATION

Please read and understand this entire manual before attempting to assemble, install or operate the product.

WARNING

- RISK OF ELECTRIC SHOCK - Before beginning installation, turn off electricity at the circuit breaker box or the main fuse box.
- RISK OF FIRE - Use bulbs specified by the markings and/or labels on the fixture.

CAUTION

- For your safety, read instructions completely before beginning installation.
- If in doubt about electrical installation, consult a licensed electrician.
- Turn off electricity to fixture before replacing the bulb(s).

TOOLS REQUIRED

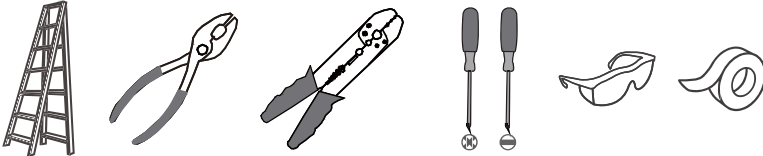

CARE AND MAINTENANCE

- Wipe clean using soft, dry cloth or static duster. Always avoid using harsh chemicals and abrasives to clean fixture as they may damage the finish.

If you need further assistance call Quozel Customer Care at 1-800-645-3184 (9:00am - 5:00pm EST), or visit us on-line at www.quezel.com.

PACKAGE CONTENTS

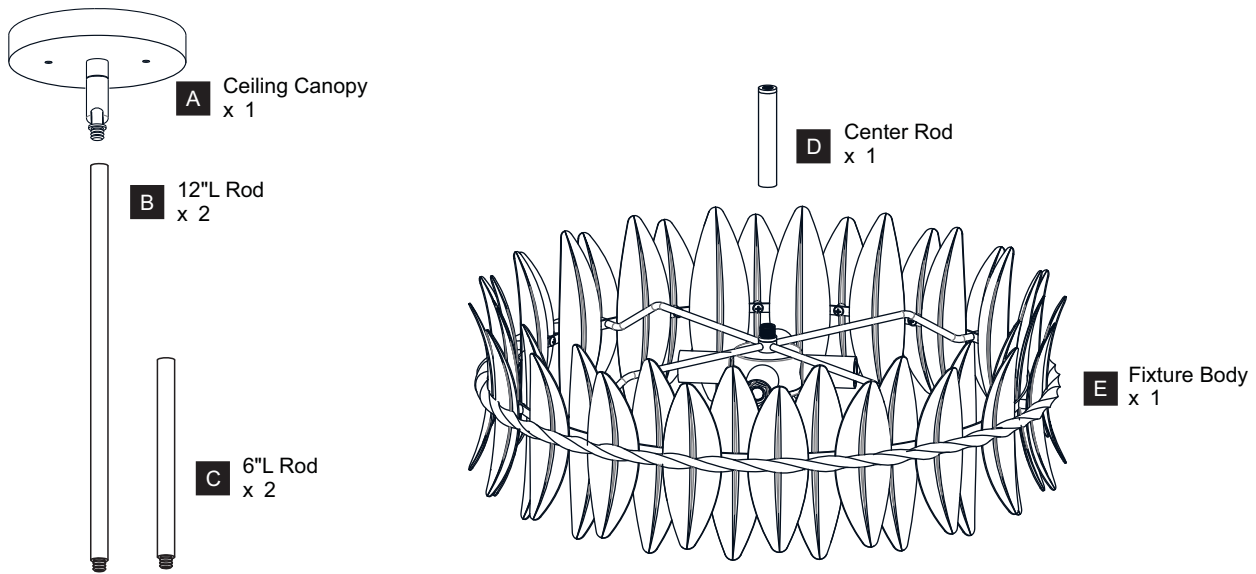

MOUNTING HARDWARE

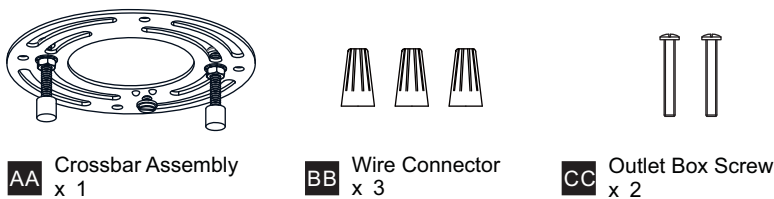

INSTALLATION

OPTION 1: PENDANT - LIZ2820GFL

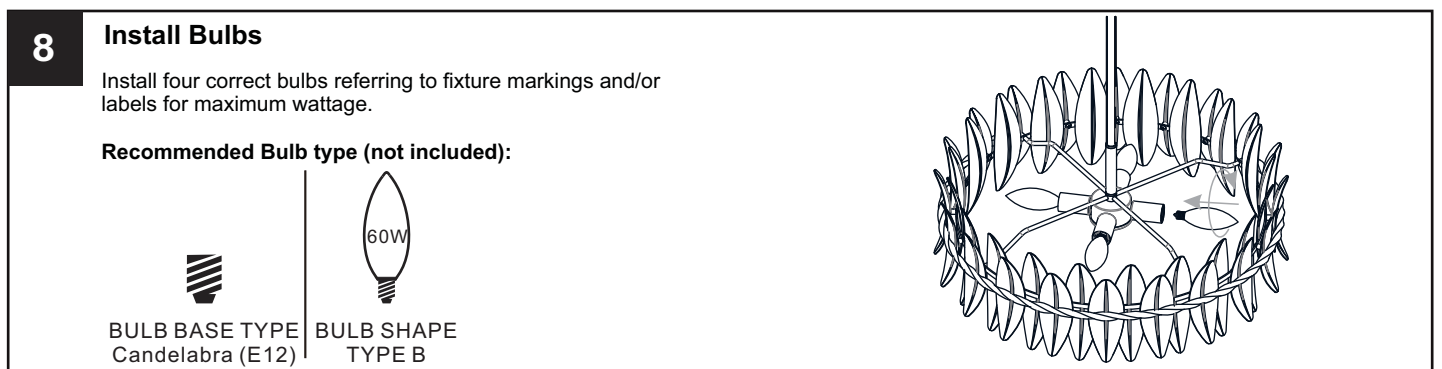
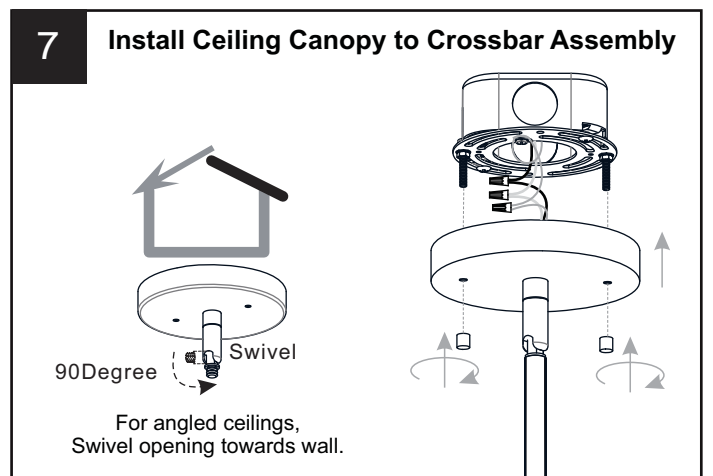
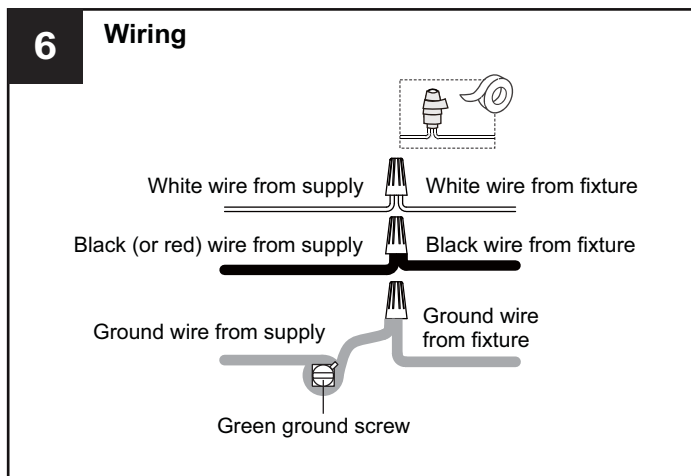
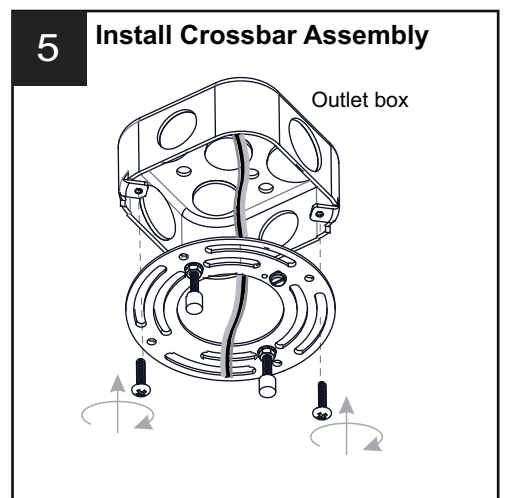
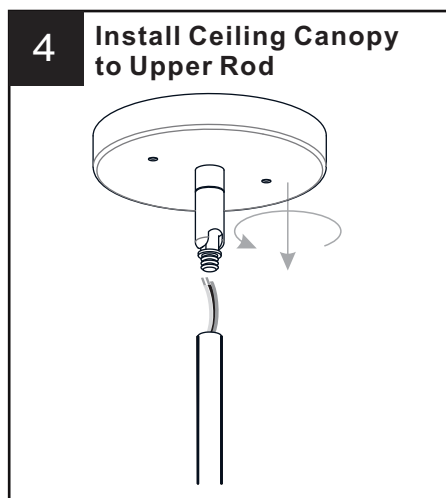
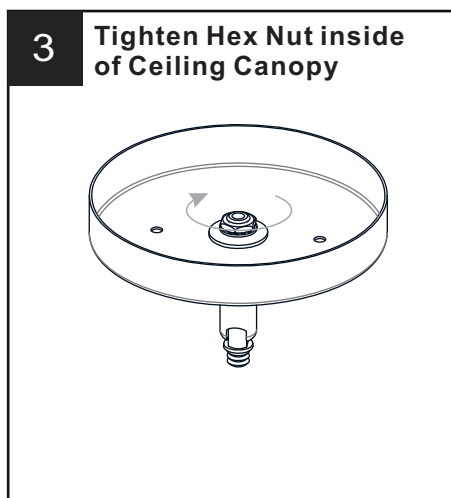
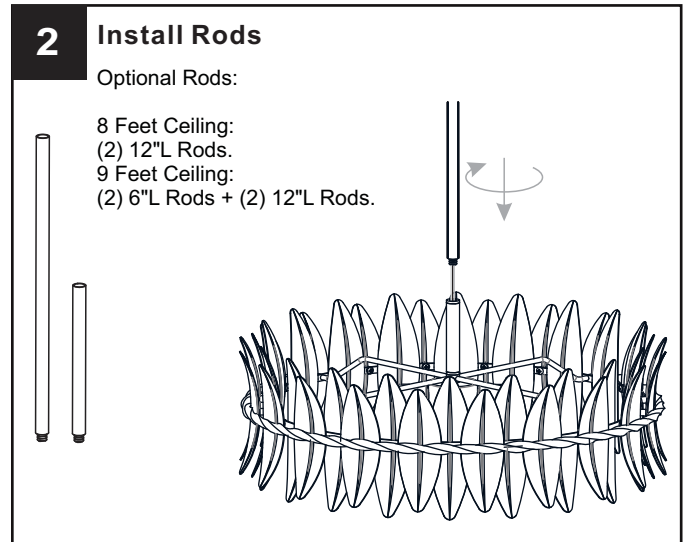
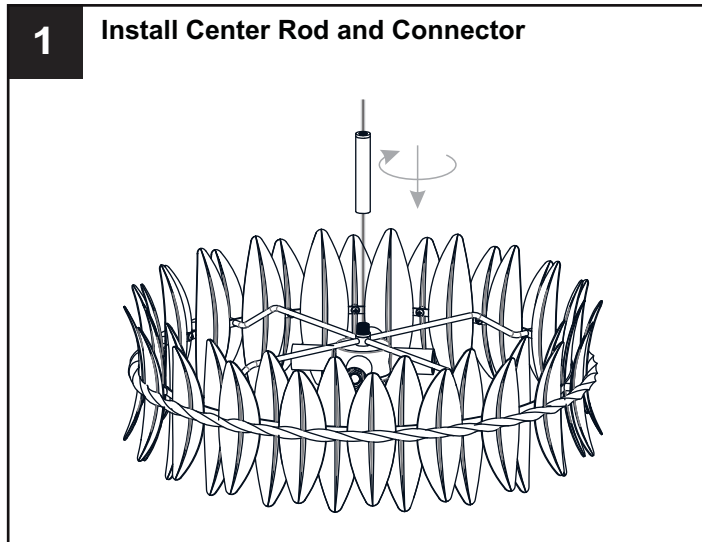

Your installation is now complete! Restore electricity and save this sheet for future reference.

INSTALLATION

IMPORTANT: This CONVERTIBLE fixture can be mounted as pendant light or semi-flush light. **DO NOT CUT SUPPLY WIRES** if you intend to use it as pendant light.

OPTION 2: SEMI-FLUSH - LIZ1720GFL

* Set aside (2) 6"L Rods and (2) 12"L Rods since they are not required for the semi-flush installation.

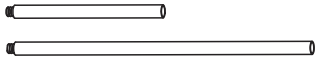

1 Remove Swivel from Ceiling Canopy

* Set aside the swivel since it is not required for the semi-flush installation.

2 Install Center Rod and Connector

3 Install Ceiling Canopy

4 Install Crossbar Assembly

Outlet box

5 Wiring

White wire from supply White from fixture

Black (or red) wire from supply Black from fixture

Ground wire from supply Ground wire from fixture

Green ground screw

6 Install Ceiling Canopy to Crossbar Assembly

7 Install Bulbs

Install four correct bulbs referring to fixture markings and/or labels for maximum wattage.

Recommended Bulb type (not included):

BULB BASE TYPE: Candelabra (E12)

BULB SHAPE TYPE: B

60W

Your installation is now complete! Restore electricity and save this sheet for future reference.