

Please go to [www. quozel. com](http://www. quozel. com) for product cleaning tips. Go to the **Care + Maintenance** selection.

**Tools Required:** Flathead screwdriver, Phillips screwdriver, pliers, wire cutters, wire strippers, electrical tape, safety glasses.

**Light Source:** Integrated LED 37W

**Compatible Dimmer Switches:** Lutron AYCL-153P or Lutron DVCL-153P.

**Estimated Assembly Time:** 20-30 minutes

**Preparation:** Identify and inspect all parts before beginning installation. Check package content list and diagrams below to be sure all parts are present. If any parts are missing or damaged, do not attempt to assemble, install, or operate the fixture. Contact customer service for replacement parts.

### **⚠ Warnings and Cautions**

Turn off electricity at circuit breaker or main fuse box before installation. Consult a licensed electrician if in doubt.

These instructions are provided for your safety. It is very important you read them completely before installing the fixture. We strongly recommend that a licensed, professional electrician perform the installation.

### Package Contents

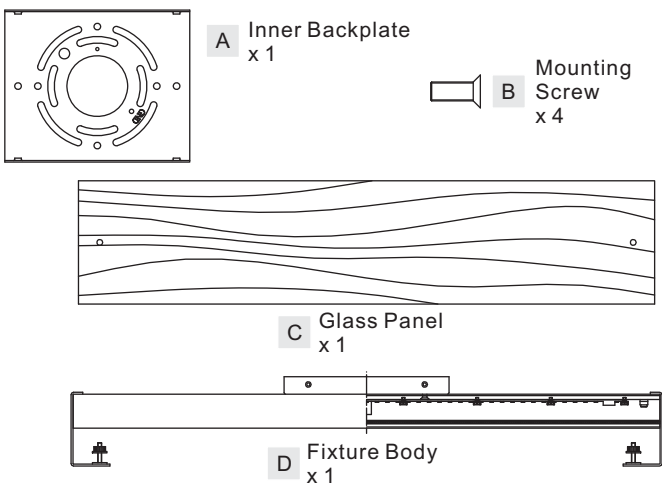

### STEP 2 – Install Inner Backplate

A. Pass the supply wires and ground wire through the Inner Backplate (A). Attach the Inner Backplate (A) to Outlet Box with the head of Green Ground Screw facing you. Secure it with Outlet Box Screws (not included). Tighten until snug.

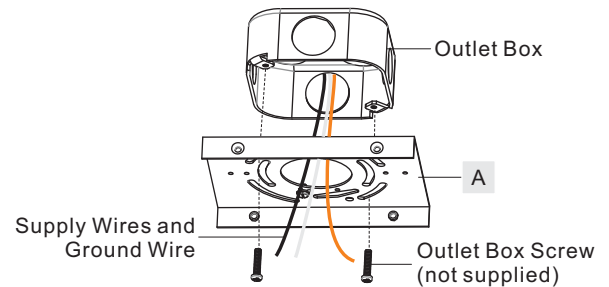

Figure 2

### STEP 1 – Install Glass Panel to Fixture Body

- Place the Fixture Body (D) onto a flat working surface. Unlock lock screws from the back of the Fixture Body (D) and remove the glass holder on both ends.
- Remove lock nuts and rubber washers from glass holders. Attach the Glass Panel (C) to the bolts on glass holders. Secure by threading rubber washers and lock nuts back onto bolts. Hand tighten until snug.
- Attach glass holders back onto the Fixture Body (D) and secure with previously removed lock screws. Tight until snug with screwdrivers.

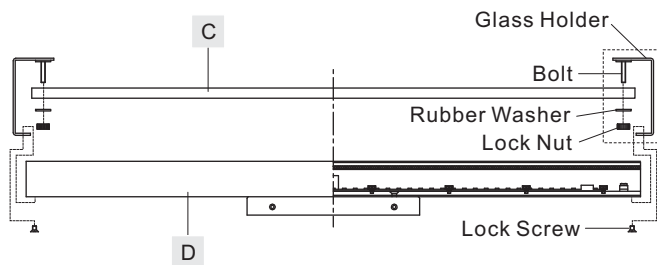

Figure 1

### STEP 3 - Wire Connections

- Wrap bare or green ground wire around green ground screw on the crossbar, no less than 2 inches from the end of the wire. Tighten the green ground screw.
- Use standard wire connectors (not included) to make all wire connections. Twist connectors until wires are tightly joined together. Wrap each connection with approved electrical tape and carefully stuff all the connected wires into the Outlet Box.

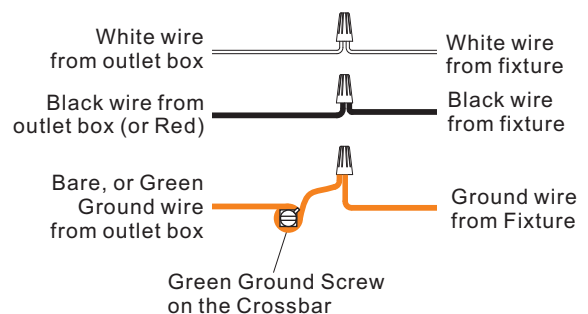

Figure 3

**Thank you for purchasing a Quoizel product.**  
**Need assistance with parts or assembly? Call Quoizel customer service at 1-800-645-3184**  
**or visit us on-line at [www. quozel. com](http://www. quozel. com)**

**STEP 4 - Install Fixture Body**

A. Place the backplate and Fixture Body (E) over the Inner Backplate (A) and secure with Mounting Screws (B). Hand tighten until snug with screwdrivers.

Your fixture is now assembled and ready to use. Enjoy!

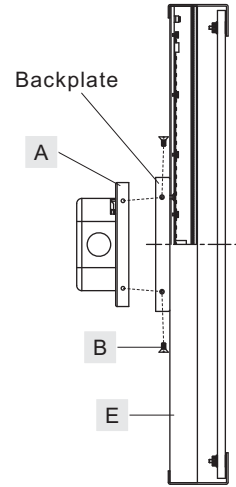
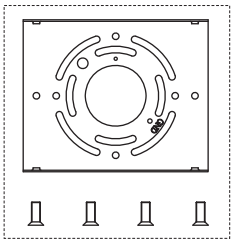

Figure 4

PCWR8524C

FINISH: POLISHED CHROME



NOTE: ALL DIMENSIONS ARE ROUNDED UP TO THE NEAREST 1/4"

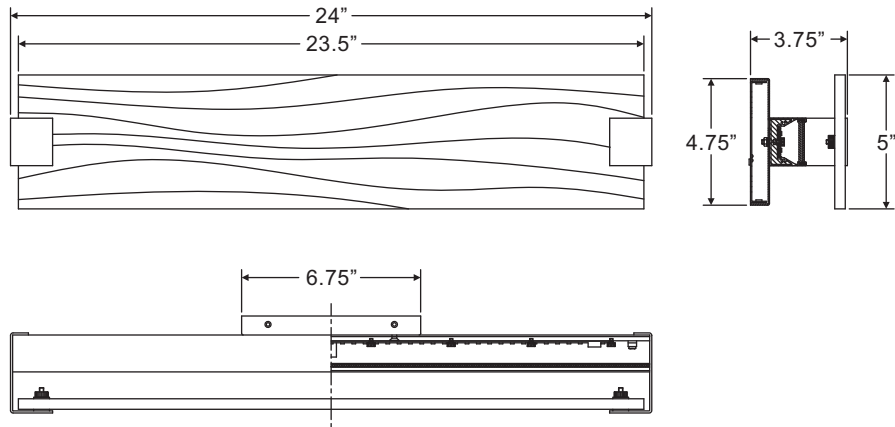

Thank you for purchasing a Quoizel product.  
Need assistance with parts or assembly? Call Quoizel customer service at 1-800-645-3184  
or visit us on-line at [www.quoizel.com](http://www.quoizel.com)