

Please go to www.quirzel.com for product cleaning tips. Go to the **Care + Maintenance** selection.

Tools Required: Flathead screwdriver, Phillips screwdriver, pliers, wire cutters, wire strippers, electrical tape, safety glasses.

Light Source: (1) Medium Base Type-A bulb (not supplied), Maximum 100W.

Estimated Assembly Time: 30-45 minutes

Preparation: Identify and inspect all parts before beginning installation. Check package content list and diagrams below to be sure all parts are present. If any parts are missing or damaged, do not attempt to assemble, install, or operate the fixture. Contact customer service for replacement parts.

⚠ Warnings and Cautions

Turn off electricity at circuit breaker or main fuse box before installation. Consult a licensed electrician if in doubt.

These instructions are provided for your safety. It is very important you read them completely before installing the fixture. We strongly recommend that a licensed, professional electrician perform the installation.

Disconnect fixture from power source before replacing bulbs. Make sure bulbs are given sufficient time to cool before removal. Do not subject glass parts to any shock while in operation or shattering may result.

Package Contents

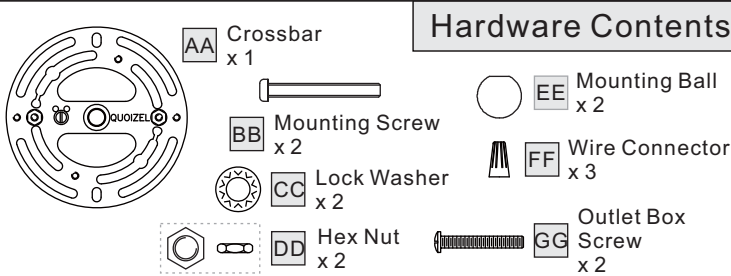
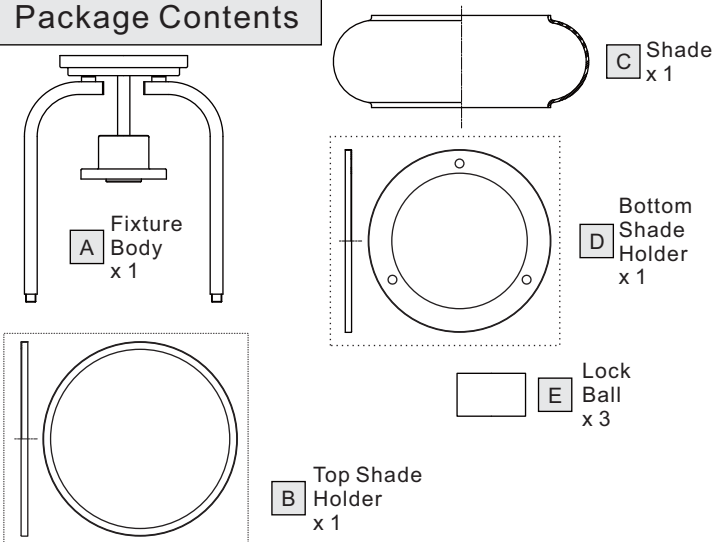

STEP 1 - Install Mounting Screws and Crossbar

A. Screw Mounting Screws (BB) into the Crossbar (AA), place Lock Washers (CC) over Mounting Screws (BB) and thread Hex Nuts (DD) onto Mounting Screws (BB) as shown. Secure positions of Mounting Screws (BB) by tightening Hex Nuts (DD) against the Crossbar.

B. Secure the Crossbar (AA) to the Outlet Box with Outlet Box Screws (GG).

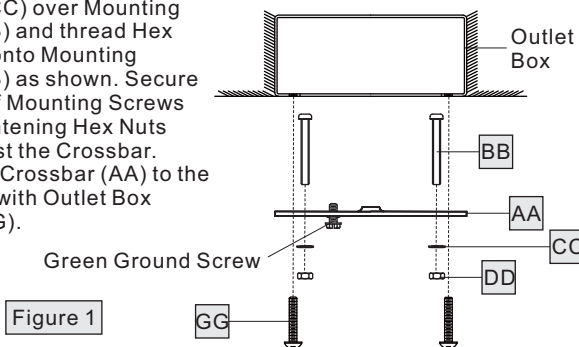

Figure 1

STEP 2 - Test Fitting Ceiling Canopy to Crossbar Assembly

A. Fit the ceiling canopy on Fixture Body (A) to Mounting Screws (BB) and secure with Mounting Balls (EE). Note: The ceiling canopy on Fixture Body (A) should be snug against the ceiling and Mounting Balls (EE). If not, adjust the length of Mounting Screws (BB) by unscrewing the Hex Nuts (DD) and Lock Washers (CC) and then screwing Mounting Screws (BB) in or out of the Crossbar (AA) until the correct length is achieved. Once the ceiling canopy on Fixture Body (A) is secure, remove Mounting Balls (EE) and Fixture Body (A) and proceed to Step 3.

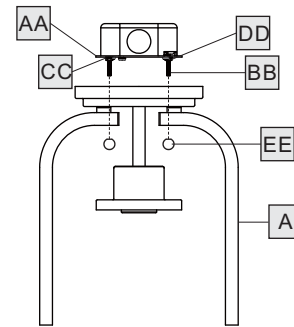

Figure 2

STEP 3 - Wire Connections

A. Use standard wire connectors (FF) to make all wire connections. Twist connectors until wires are tightly joined together. Wrap each connection with approved electrical tape and carefully stuff all the connected wires into the Outlet Box.

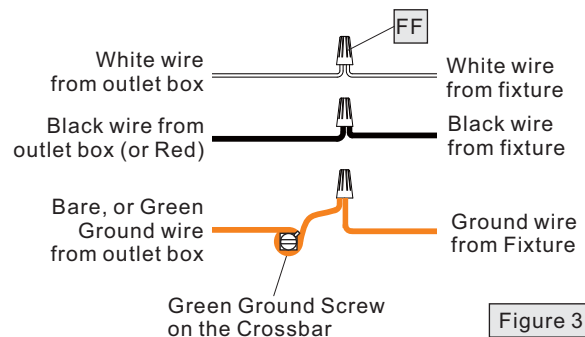

Figure 3

STEP 4 - Install Fixture Body

- A. Carefully tuck all wires into the outlet box and position the ceiling canopy of Fixture Body (A) over the outlet box. Align the holes in the ceiling canopy with Mounting Screws (BB) and secure with Mounting Balls (EE). Hand tighten until snug.

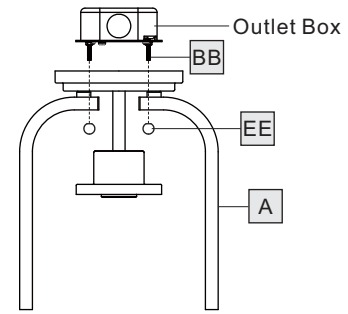

Figure 4

STEP 5 - Install Shade and Bulb

Two people are required for this step.

- A. Place the Ring (B) over the top edge of the Shade (C). Place bottom edge of the Shade (C) into the Shade Holder (D).
- B. Lift the Shade assembly up and pass the Arms of the Fixture Body (A) through the Shade (C). Position the holes on the Shade Holder (D) to the Arms on the Fixture Body (A).
- C. The second person is to secure the Shade Holder (D) by threading the Lock Balls (E) onto the ends of the Arms of the Fixture Body (A). Hand tighten until snug.
- D. This fixture uses medium base Type-A bulb (not supplied) with standard screw base. Maximum 100 watts. Insert bulb and screw snugly into place.

Your fixture is now assembled and ready to use. Enjoy!

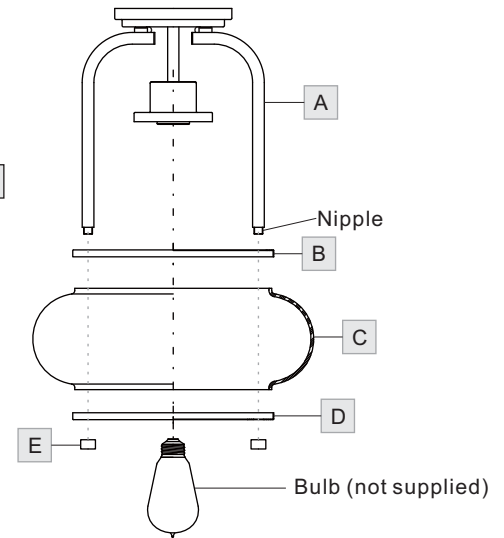

Figure 5